

Beltholder Diamantlift

Floor fixation

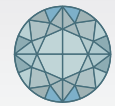



DIAMANTLIFT

Please note:

This kind of fixation is not suitable for underfloor heating!

Surface beltholder

-  Stainless steel
-  Powder coating white

different heights are available

-  51 cm
-  46 cm
-  41 cm
-  5 cm

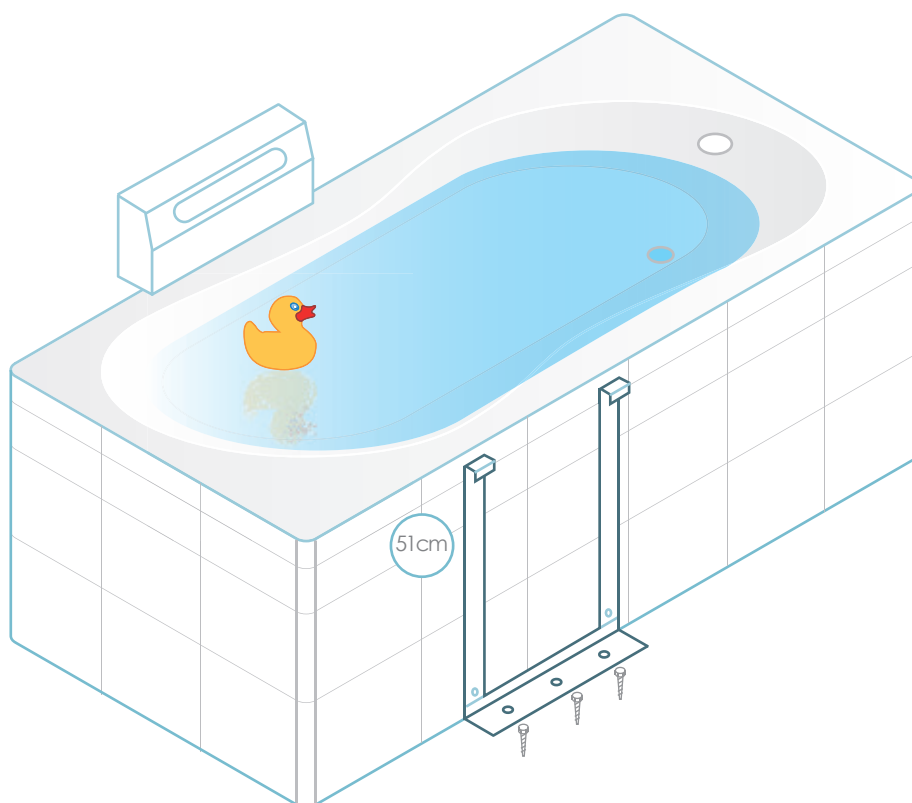
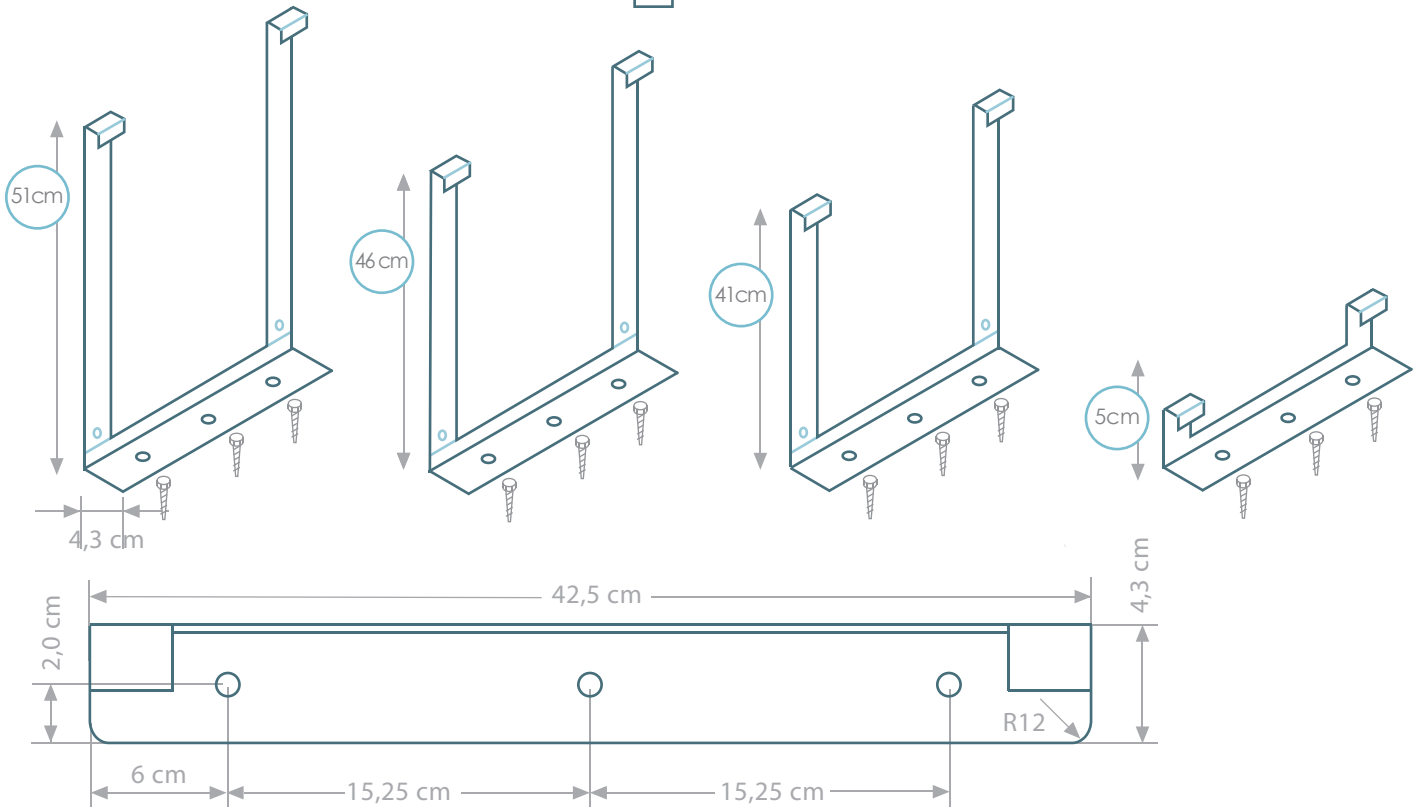

Take a ruler and measure the height of the bathtub. Subtract at least 5 cm from the measured value and choose the standard height that is closest to the calculated value. (51 cm, 46 cm oder 41 cm)

Example: Your bathtub has a height of 54 cm from the floor. After the deduction of 5 cm you have a value of 49 cm. The closest standard height would be the belt holder with a height of 46 cm.

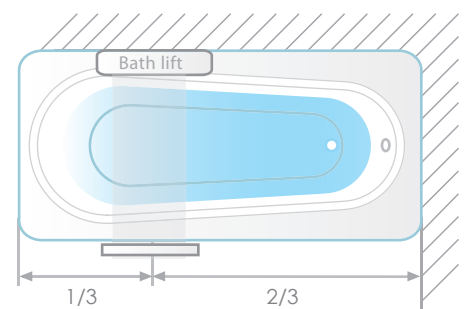

Beltholder Diamantlift Side fixation

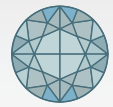

DIAMANTLIFT

Please note:

This kind of fixation is not possible on polystyrene tub supports!

Surface beltholder

- Stainless steel
- Powder coating white

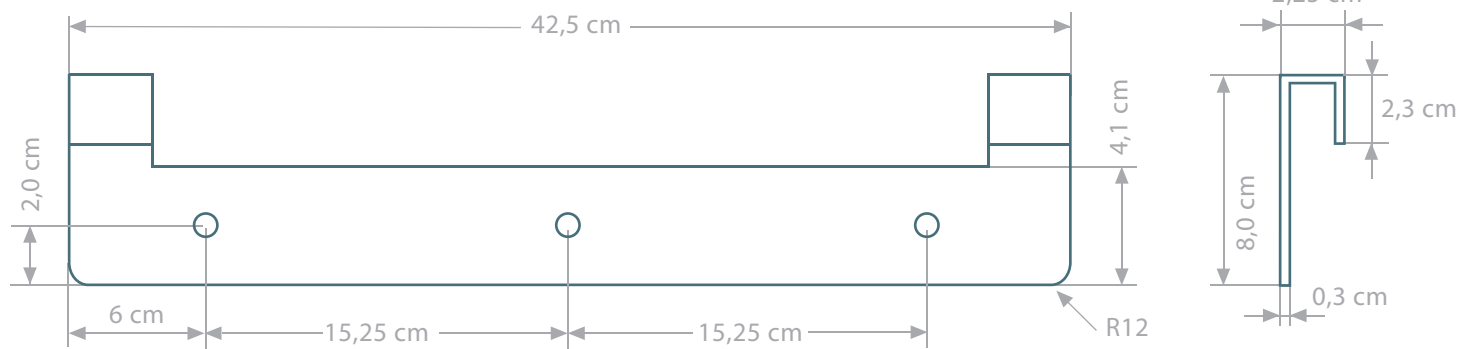
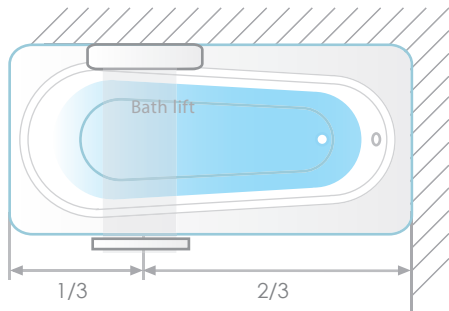
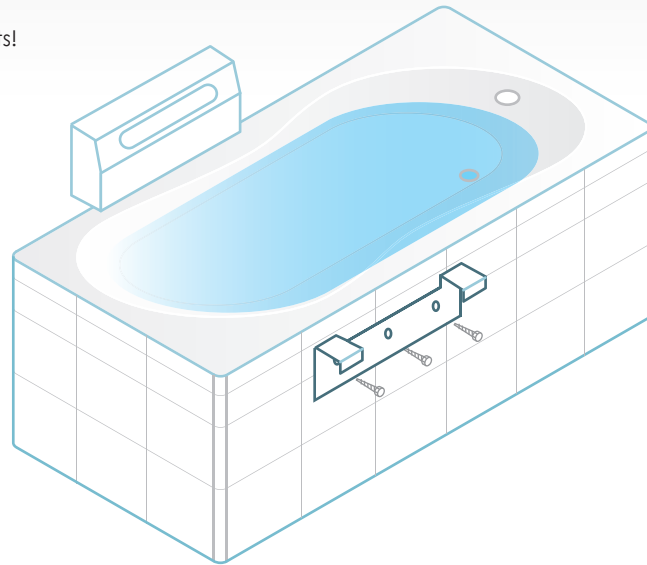

Wall fixation (for front mounted bath lift)

Surface beltholder

- Stainless steel
- Powder coating white

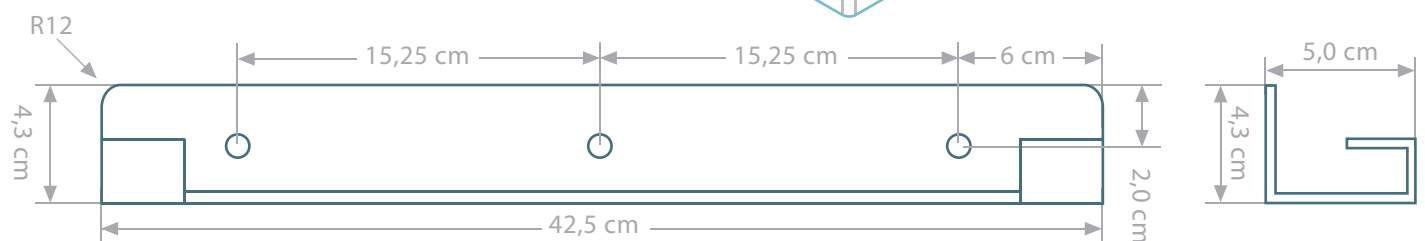
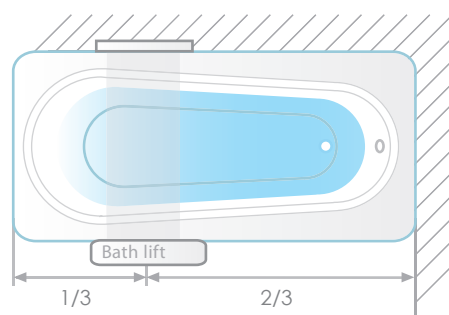
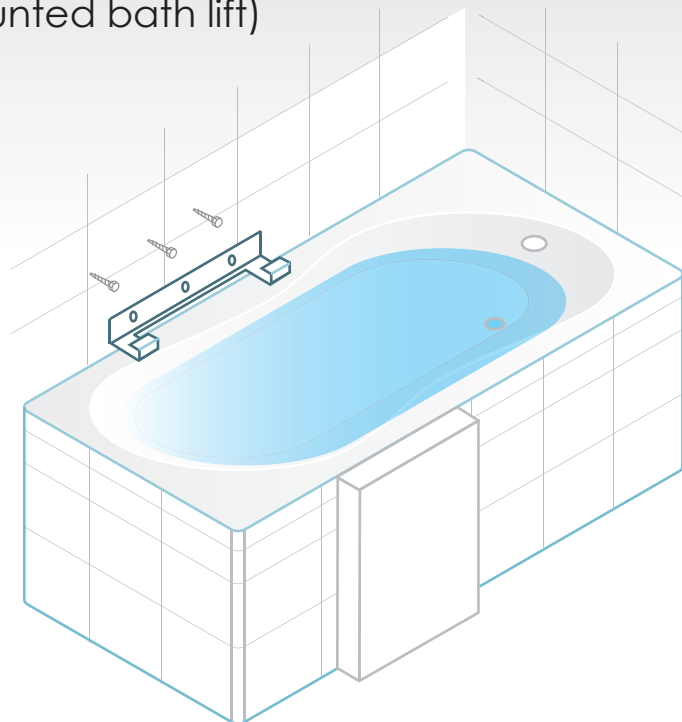

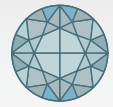

Beltholder Diamantlift adjustable bracket



DIAMANTLIFT

Surface beltholder

-  Stainless steel
-  Powder coating white

